

Performance Evaluation of E32 Long Range Radio Frequency 915 MHz based on Internet of Things and Micro Sensors Data

by Puput Dani Prasetyo Adi

Submission date: 28-Oct-2021 03:25AM (UTC+0700)

Submission ID: 1685902028

File name: -_Performance_Evaluation_of_E32_Long_Range_Radio_Frequency1.pdf (1.94M)

Word count: 6913

Character count: 33562

Performance Evaluation of E32 Long Range Radio Frequency 915 MHz based on Internet of Things and Micro Sensors Data

Puput Dani Prasetyo Adi¹, Akio Kitagawa²
Micro Electronics Research Laboratory (MeRL)
Kanazawa University, Kanazawa
Ishikawa, Japan

Abstract—This research discusses how to build and analyze a 915 MHz Long Range (LoRa) E32 Frequency-based Node Sensor network with a Micro Sensor with 3 sensor outputs produced i.e. Temperature (DegC), Air Pressure (hPa), and Humidity (%). therefore, This research succeeded in making a sensor node using the LoRa E32 915 MHz using a mini type ATmega 328p microcontroller with a 3.7 volt, 1000 mAh battery. The display on the receiver uses an 8X2 LCD which will output 3 sensor data outputs. furthermore, the result and analysis of this research are how to analysis of the LoRa Chirp Signal, furthermore, LoRa Chirp Signal obtained from the Textronix Spectrum analyzer in realtime, Quality of Service (QoS), Receive Signal Strength Indicator (RSSI) (-dBm), uplink and downlink data on the Internet Server. Furthermore, The Micro Sensor Graph Output will be displayed on the application server with a sensor data graph. In this research Application Server used is Thingspeak from Mathworks.

Keywords—Long range; microcontroller; internet of things; quality of service; micro sensor

I. INTRODUCTION

The development of the Internet of Thing is currently growing rapidly, Sensor Nodes are developed with very low power consumption with long node durability, supported by the right environment and the right battery usage, in research [1] and [2], sensor nodes are used in delivery of Internet-based Pulse Sensors and Blood Pressure sensors with IoT devices with ZigBee sending devices. The advantages of ZigBee are Low Power, with a data rate of 250 kbps, but weak in the distance (m), a maximum of 120 meters on a regular type ZigBee, and 1 km on a ZigBee Pro. So the development is done by changing the radio frequency device with Long Range (LoRa). LoRa center frequency e.g. 433 MHz, 868 MHz, and 915 MHz. for Asia, e.g. Japan and Indonesia use Frequency Long Range (LoRa) 920-923 MHz (Center 915 MHz). The type of signal produced by LoRa is Chirp Signal as in research [3]. In research [4], using Bluetooth type RN-42 in sending LM35 temperature sensor data, and using Raspberry Pi 3 Model B, the resulting analysis is Quality of Services (QoS) on Bluetooth RN42 Master-Slave communication and data management process on Raspberry Pi 3 using Python and MySQL or MariaDB databases. Research [2] was developed with subsequent research using GUI (Graphical User Interface) using JavaScript Object Notation (JSON) and Application Server, e.g. The Things Networks (TTN) and

Thingspeak. Fig. 1 shows the comparison between Frequency radio devices e.g. WiFi, Bluetooth, Bluetooth LE, Cellular and LoRaWAN. Using Cellular and GSM technology e.g., in research [5] studies on how to detect water distances using Ultrasonic sensors and GSM SIM 900A. Furthermore, still, on the application of Radio Frequency, namely in research [6], LoRa is used in Street Light monitoring.

This comparison uses two parameters, i.e. the ratio of Power Consumption to distance. With a distance of ≥ 15 km on Free Space, placing LoRa or LoRaWAN in the best ranking compared to other devices. LoRaWAN can be paired with Cellular Devices in terms of Range but Cellular cannot match LoRaWAN in terms of Power Consumption. Therefore, LoRa and LoRaWAN only use battery power sources with the ability to survive > 2 years. nevertheless, LoRaWAN is the most ideal device that can be used as a sensor node based on Low Power and with the best data transmission range.

LoRa can > 30 km, in the condition of Free Space, of course, with the right antenna position and an adequate transmitter Antenna height. In research [7], packet loss is calculated for different coverage of SF12 use in indoor and outdoor conditions. In research [8] very detailed in testing the reliability of LoRa signal and LoRa transmission data (bit rate, data rate), Receive Signal Strength Indicator (RSSI), Error Bit Rate (EBR (%)) and EPR (Error Packet Rate (%)), Packet Delivery Ratio (PDR(%)) juga dilakukan menggunakan perbandingan simulasi menggunakan LoRaSIM [9].

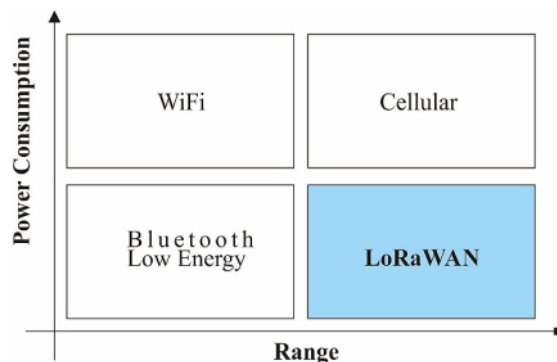

Fig. 1. Radio Frequency Devices with Power Consumption and Range Comparison.

II. RELATED WORKS

Research [10] analyzed the Parameter Packet Delivery Ratio (PDR (%)) from direct measurements using Locations A, B, C, D, and E., In theory, these locations show a Spreading Factor (SF) parameter of 7 to 7 12. If the greater the Spreading Factor, the smaller the Packet Delivery Ratio (PDR (%)). The closest distance is A is 650 m and the farthest E is 3400 m. furthermore, the analysis was also carried out by making a comparison of average throughput (bytes / s) with Spreading Factor (SF). The greater the SF value, the smaller the value of Throughput (bytes / s). In SF 7 the average value of 3 payloads is 51 bytes, 25 bytes and 1 byte is 3.96 bytes / s and in Spreading Factor 12, from 3 payloads of 51 bytes, 25 bytes, and 1 byte, the average throughput is 0.22 bytes / s.

Research [3] conducted a detailed analysis of Chirp Signal or CSS. chirp Signal Analysis, including Up chirp and down chirp. This research emphasizes more on the fundamental aspects of LoRa i.e. parameters, demodulation process, and Decoding Process. Furthermore, the CSS Packet Spectrogram comparison between Frequency LoRa (125 kHz, 250 kHz, and 500 kHz) against Time (ms) with Spreading Factor (SF) differs from 7 to 12. And the results of the simulation are the comparison between SF and SNR (-dB).

Research [11] analyzed in detail the Signal Interference Ratio (SIR) by comparing the detailed Spreading Factor (SF) Parameters e.g., Co-Spreading Factor Interference. LoRa parameters are obtained with a detailed mathematical approach that results in the Probability of Success (Ps) with parameters e.g., P_{SNR} , P_{SIR} , and Simulation with a Comparison of distances (km). the research compared the value of R = 6 km and R = 12 km.

III. METHODOLOGY AND DEVICES USED

A. Chirp LoRa Signal

Compressed High-Intensity Radar Pulse (chirp) is signal modulation technique has long been used in the world of commercial and Military RADAR Systems. therefore, There are 3 types of signal modulation, e.g. Amplitude Shift Keying (ASK), Frequency Shift Keying (FSK) and Phase Shift Keying (PSK). furthermore, Amplitude Shift Keying (ASK) is a modulation signal based on the change in the value of the amplitude is high or the low wave signal is generated, if the amplitude of high-value and low-amplitude digital 1 digital is worth 0. Frequency Shift Keying (FSK) is a modulation signal which is based on the change in frequency indicated by the Pulse Length (t) value or the resulting signal density as shown in Fig. 2 and Fig. 3. In Fig. 2, the parameters are as follows.

$$t=0:0.05:10; A=1; \omega=2; s_t \\ = t.^2/4; y_t=A*\cos(\omega*t + s_t)$$

t is the Pulse Length in Fig. 2 using the value t = 10 and Fig. 3 the value of t = 40.

Like Fig. 2, Fig. 3 has the following parameters

$$t=0:0.05:40; A=1; \omega=2; s_t = t.^2/4; y_t=A*\cos(\omega*t + s_t);$$

The signal in Fig. 1 can be formulated with equation 1, while for Fig. 3 it can be expressed with equation 2. If it is formulated with general function the signal for signal density is like equation 3.

$$\sin\left(\frac{1}{2}\pi\left(\left(\frac{2x}{3}+1\right)^2-1\right)\right) \quad (1)$$

$$\sin(\pi((\pi+1)^2-1)) \quad (2)$$

$$y(a,b,c,d) = c \sin\left\{\frac{\pi}{b-a}\left[\left((b-a)-\frac{x}{d}+a\right)^2-a^2\right]\right\} \quad (3)$$

while Phase Shift Keying (PSK) is a signal modulation based on signal shifting, not high or low amplitude or signal density. Furthermore, the value of signal modulation is 1 and 0, digital value 1 indicates ON and digital 0 states OFF. of several types of signal modulation, LoRa uses the Chirp type or called the Chirp Spread Spectrum (CSS), there are two types of Chirp namely Frequency Increases (Up-Chirp) and Frequency decrease (Down-Chirp) with time, as shown in Fig. 4.

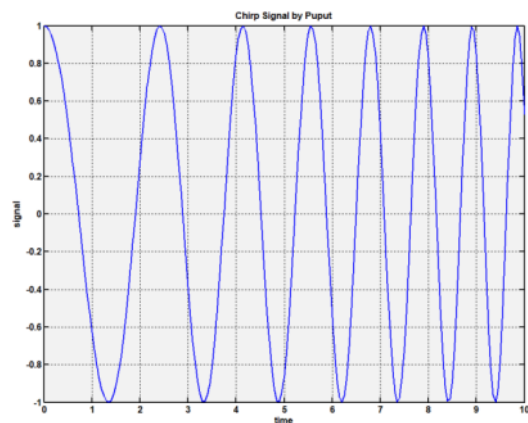

Fig. 2. Chirp with t = 10.

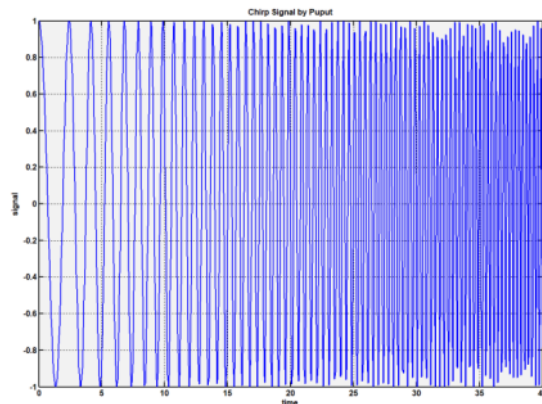

Fig. 3. Chirp with t = 40.

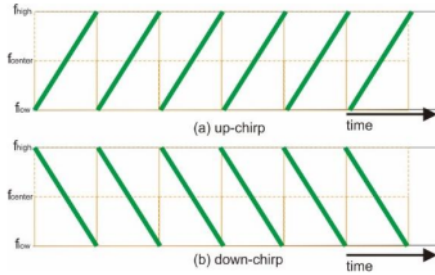

Fig. 4. Up and Down-Chirp Signal LoRa.

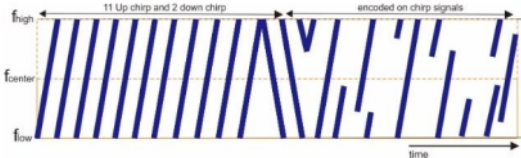

Fig. 5. LoRa Signal with Encoded (data) on.

Fig. 5 contains 2 signal parts i.e., up and down chirp signal on the LoRa signal prefix, consisting of 11 up chirp and 2 down chirp. Next is the encoded signal. Fig. 8 is the realtime LoRa E32 signal that is the Chirp signal captured and analyzed by the Textronix Spectrum analyzer.

In research [12], a decoding technique for LoRa signals was used using a decoding algorithm with two slightly desynchronized superposed LoRa Signals. furthermore, this decoding Algorithm technique is used to increase the effectiveness of sending data e.g, Throughput.

B. BME280 Sensor

The BME280 Sensor is a multi-sensory and applied in the Health Care Application (e.g. Spirometry). in previous research, Health Care Application using different sensors in research [1], [2] i.e. Blood Pressure and Pulse Sensor Internet of Things (IoT) based. BME280 sensor has a three types of Sensors, i.e. Atmospheric Pressure (hPa), Temperature (DegC) and Humidity (%). Atmospheric Pressure (hPa) is pressure at any point in the Earth's atmosphere. Almost the same as the hydrostatic pressure caused by the weight of the air above the measurement point. Table I is the specifications of the BME 280 Sensor.

TABLE. I. BME 280 SPECIFICATION

No	Parameter	Details
1	Dimension	2.5 mm x 2.5 mm x 0.93 mm metal Lid LGA
2	Digital Interface	I ² C (up to 3.4 MHz) and SPI (3 and 4 wire, up to 10 MHz)
3	Supply Voltage	V _{DD} main supply voltage range 1.7 V to 3.6 V V _{DDIO} Interface voltage range : 1.2 V to 3.6 V
4	Current consumption	1.8 μA @ 1 Hz humidity and temperature 2.8 μA @ 1 Hz Pressure and temperature 3.6 μA @ 1 Hz humidity, Pressure and temperature 0.1 μA in sleep mode
5	Operating range	-40 ... +85° C, 100% rel.humidity, 300..1100 hPa

The formula for calculating Atmospheric Pressure is in accordance with the formula 2. $\text{Log}_{10} P \approx 5 - (h - 15500)$, where the value of P is Pressure (Pascal) and h is the height (meters) Furthermore, the temperature has the default unit Degree Celsius. the BME280 sensor, the unit used is Degree Celsius and detects conditions in the environment and results in precision. furthermore, to change to Kelvin (K), Reamur (R) or Fahrenheit (F) C language is used in the Arduino IDE. If the DegC value is known, to be changed to another temperature unit to $r = c * 4/5$; $f = (c * 9/5) + 32$; $k = c + 273.16$; furthermore, Humidity (%) is the amount of water vapor in the air that is not visible to the human eye, this amount of water vapor will determine rainfall, dew or fog. Furthermore, Fig. 6 describes the BME280 sensor diagram block, There is a Pressure and Temperature Sensing element that is converted from Analog to Digital using Analog to Digital Converter (ADC) to Logic Gate and continues to 6 Output pins i.e.SDI, SDO, SCK, CSB, VDD and GND, and just 4 pins used i.e. SDA, SCL, VDD (3.3 Volt) and GND.

This sensor will be processed by the MCU (ATmega 328) with BME280 pins on the Arduino Pro mini such as Fig. 3. In Fig. 3, three main components of a sensor node, i.e. MCU ATmega 328, FTDI and LoRa. The LoRa type used is SX1276 a Universal Asynchronous Receiver Transmitter (UART) E32 915T20D, this type of LoRa has the capability of up to 3 km. The LoRa SX1276 UART E32 915T20D uses a default frequency of 915 MHz (920-928 MHz), this Radio Frequency can be used in Japan (920-928 MHz). A block diagram of the BME280 can be seen in Fig. 7.

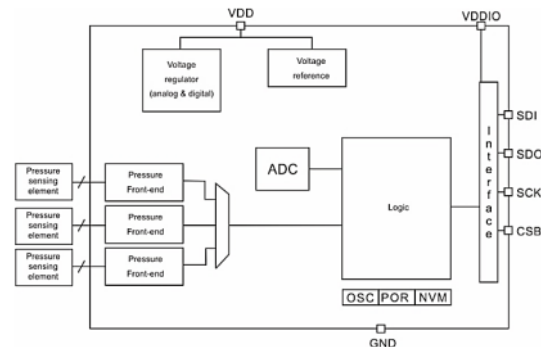

Fig. 6. Block Diagram of BME280 Sensor.

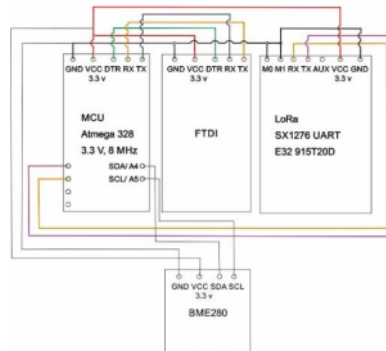

Fig. 7. Block Diagram of BME280 Sensor on MCU ATmega 328.

Battery Life Factor is the most important factor in the LoRa or LoRaWAN network architecture, in research [13] reviewed how to make energy consumption on Sensor nodes in LoRa or LoRaWAN networks can survive well with the approach in Sleep mode. In addition to the Sleep mode approach, the effectiveness of the sensor node and the LoRaWAN network with a multi-node or multi hope is to use a method called the offset-CT Method, as in research [14].

The calculation approach to the node usage on the Receiver is as follows, as in references [1], the calculation of the Power Consumption of Sensor node is based on the total load calculation component used, the Battery life calculation is in accordance with equation 4, furthermore, 0.7 is a value of external factors which can affect battery life. A sensor nodes (Tx and Rx) can be seen in Fig. 8. Furthermore, The type of battery used in the sensor node is the 3.7 Volt 1000 mAh Lithium Polymer Li-Po Rechargeable Battery as shown in Fig. 9.

1) *Measurement of battery life (H) of receiver node:* In measurements using the Ampere meter in Fig.10, the total value of the Power Consumption mote or node sensor on the receiver (Rx) with LoRa E32 is 22 mA. so that the Battery Life mote according to equation 4 is $1000 \text{ mAH} / 22 \text{ mA} = 45.45 \times 0.7 = 31.8$ hours. accordingly, This formula is the same as finding power ($P \text{ (watts)} = V \text{ (Volts)} \times I \text{ (Amperes)} = P_{\text{sensor}} = 3.7 \times 0.022 = 0.0814$ watts, so $P_{\text{battery}} = 3.7 \times 1 \text{ Amperes} = 3.7$ watts, so the Power Required is $3.7 / 0.0814 = 45.45 \times 0.7 = 31.8$ Hours.

2) *Measurement of battery life (H) of transmitter node:* On the transmitter, the total current sensor node is 119.5 mA, then Battery Life mote = $1000 \text{ mAH} / 119.5 \text{ mA} = 8.36 \times 0.7 = 5.8$ hours. This formula is the same as finding power ($P \text{ (watts)} = V \text{ (Volts)} \times I \text{ (Amperes)} = P_{\text{sensor}} = 3.7 \times 0.1195 = 0.44215$ watts, so $P_{\text{battery}} = 3.7 \times 1 \text{ Amperes} = 3.7$ watts, so the Power Required is $3.7 / 0.44 = 8.4 \times 0.7 = 5.8$ Hours. Furthermore, to reduce the Battery life (H) Sensor node it is necessary to do a strategy on the sensor node by changing the C language programming on the MCU to Sleep mode. With Sleep mode or Reset mode, Battery Life (H) can be longer, in Sleep mode it can be set how long the sensor node will sleep, and when the sensor node will turn on again and send a signal.

C. LoRa 915 MHz (920-928 MHz)

The RF signal used in this research is two types, i.e. Dragino LoRa 915 MHz and LoRa SX1276. LoRa SX1276 uses the default frequency of 915 MHz (Japan: 920-928 MHz), this type of LoRa is intended for Arduino Uno Shield and Arduino Mega. Complete data about the specifications of the LoRa SX1276 915 MHz can be seen in Table I. Furthermore, this research is divided into two analyzes, i.e. the measurement of transmission devices (Transmitter and Receiver) to get the RSSI (-dBm) value and analysis of the 915 MHz Internet Gateway e.g. uplink and downlink of LoRa 915 MHz Internet gateway. In research [8] the Framework of the Distance-Ring Exponential Stations Generator (DRESG) was introduced in handling and providing Multi-hop solutions, e.g. Routing nodes, energy efficiency and consumption among

all the STAs in the Network. In research [14] conducted research transmission data using LoRa to find out energy efficiency over very long distance [15] by building communication 6 LoRa nodes which can cover 1.5 ha of network with sensor node specifications ie, 2 AA type batteries, data transmission every 5 seconds and level 80% reliability. The Lora E32 or SX1276 / SX1278 Wireless Module has variants or versions, one of E32 915T20D LoRa type shown in Fig. 5 and this type is used in this research, LoRa E32 868T20D (Permit at Japan 920-928 MHz) this Frequency radio is maximum 931 MHz, moreover the E32915T20D uses a default frequency of 915 MHz, while the E32868T20D uses an 868 MHz frequency. e.g, for the Japanese region using E32915T20D, which works in the range 920-928 MHz, therefore, the maximum frequency for E32868T20D module is 930 MHz.

The dimensions of the LoRa E32 915T20D Wireless Module have dimensions of 21x36 mm in Fig. 11. the voltage used is 3.3 Volt DC (Tipycal), Transmit Power (dBm) is 20 dBm in Fig. 12, more complete can be seen in Table II.

$$\text{Battery Life Sensor Node [H]} = \frac{\text{Battery Capacity (mAh)}}{\text{Load Current (mA)}} \times 0.7 \quad (4)$$

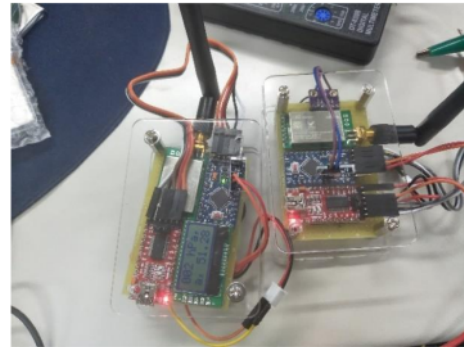

Fig. 8. DIY Transmitter and Receiver LoRa E32 915 MHz Node Sensor.



Fig. 9. Battery 3.7 Volt 1000 mAh Lithium Polymer Li-Po Battery Rechargeable.

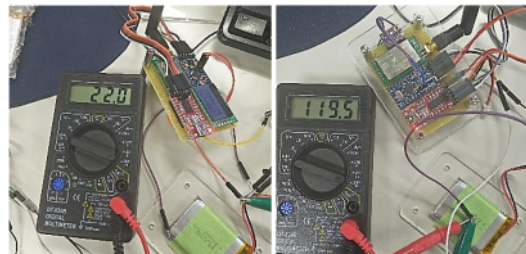

Fig. 10. Total Load Measurement of Current (mA) on Rx dan Tx Sensor Node.

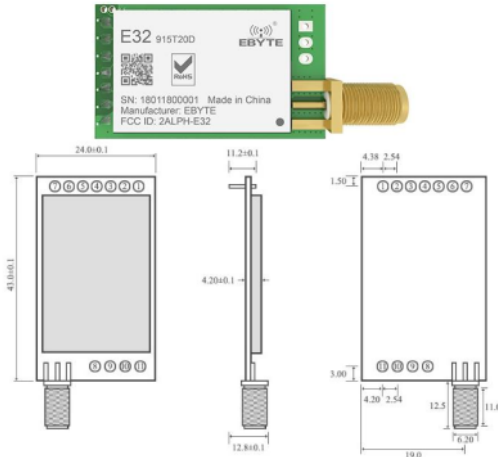

Fig. 11. LoRa E32 915T20D and Dimension.

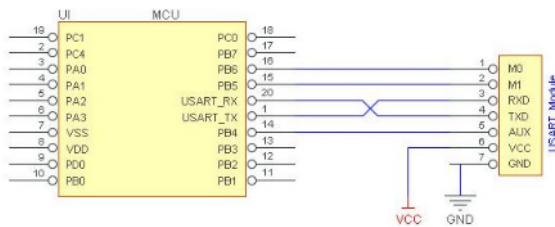

Fig. 12. Circuit Diagram of LoRa E32 915T20D.

TABLE. II. LoRa E32915T20D SPECIFICATION

No	Parameter name	Parameter detail
1	Model Wireless Module	E32 (915T20D)
2	Frequency	Min 900 MHz, Typ : 915 MHz : Max 931 MHz
3	Voltage Supply	Min: 2.3 V DC, typ: 3.3 V DC, Min: 5.2 V DC
4	Communication Level	Min: 2.5 V DC, typ: 3.3 V DC, Min: 3.6 V DC If Communication level > Maximum Value, then Module may be damaged
5	TX Power	Min :19.3 dBm, typ: 20 dBm, Max:20.6 dBm
6	TX Current	Min:110 mA, typ :120 mA, Max : 130 mA
7	RX Current	Min:11 mA, typ : 14 mA, Max :15 mA
8	Turn off Current (Sleep mode)	Min:3 mA, typ : 4 µA Max :5 µA
9	Range	Min: 2700 m, Typ : 3000 m, Max :3300 m
10	Packing	DIP
11	Air Data rate (kbps)	2.4 kbps
12	Antenna	SMA-K
13	Reception Sensitivity	-147 dbm
14	Air data rate	0.3 kbps – 19.2 kbps, default 2.4 kbps
15	Test distance	3000 m (3 km)
16	Antenna Gain	5 dBi
17	Communication Interface	UART, boud rate 1200 – 115200, default: 9600 bps
18	Transmitting Power	100 mW
19	Parity	8N1
20	Default Parameter Values	C0 00 00 1A 0F 44

In general, Lora type E32915T20D has 7 core pins that are used in the process of making sensor nodes, namely M0, M1, RXD, TXD, AUX, Vcc and GND, in full about pins and functions explained in Table III. There are 3 modes in sending sensor data to Pins M0 and M1 are Wake up mode (mode 1), if M1 and M0 = 1, then Power-saving mode (mode 2) if M1 = 1 and M0 = 0 and Sleep mode if M1 = 1 and M0 = 1.

A Zigbee using PAN ID (Personal Address Network) Identifiers, e.g, 00 03 04 AA BB CC (00 03 = Address, and 04 = Channel) will send data to other LoRa Wireless Modules, the receiver (Rx) LoRa Wireless Module have the same address and channel, e.g, 00 03 04, if address 00 05 04, message will not be sent or 00 07 04 (different address even though the channel is the same, the message will not be sent) while Broadcast Mode, FFFF will send all addresses and channels such as FF FF 04 AA BB CC can send data to 00 03 04 and 00 05 04 (Different addresses but for channels must be the same), e.g, channel 00 07 06, the data is not sent, nevertheless the channel must be 4, same as Tx (Transmitter) Lora Wireless Module. Writing the address module on the broadcast is 0xFFFF or 0x0000 and channel 0x04, while for Fix mode or point to point is 0x0003 or 0x0001.

In research [15], a study of the basic performance of LoRa, LoRa Physical layer and comparison of Sigfox and LoRa in terms of Bit Error Probability. In research [16] LoRa research on Quality of Services (QoS) e.g, RSSI, SNR, Payload size (bytes) and Spreading Factor. In research [17] LoRa performance testing on image transmission, this is a new idea because LoRa has the ability to transmit small data, in this research the image transmission was successful, the camera used has a SNR 45 dB specification and 38400 bps Boudrate, Micro SD Card as saving data and LoRa shield with Arduino MEGA as a processor (MCU) and transmitter. In research [18] testing and study of the maximum or limit LoRaWAN devices. LoRa test results in a comparison of Payload data of 10, 30 and 50 bytes, and the maximum throughput of the number of different end nodes, namely, 250, 500, 1000 and 5000 end devices.

TABLE. III. LoRa E32915T20D PINS

Pin no.	Pin	Pin direction	Application
1	M0	Input (weak pull-up)	Work with M1 and decide the four operating modes
2	M1	Input (weak pull-up)	Work with M0 and decide the four operating modes
3	RXD	Input	Connect to external TXD output pin
4	TXD	Output	Connect to external RXD input pin
5	AUX	Output	To wake up the external MCU
6	VCC	Input	Voltage positive references of module; Power Supply 2.3 Volt – 5.2 Volt DC
7	GND	Input	Ground
8	Fixing hole		Fixing hole
9	Fixing hole		Fixing hole
10	Fixing hole		Fixing hole

In research [10], the LoRa test on the Packet Delivery Ratio of the LoRa field test in SF 7, 9, 12 at 5 different locations. Also obtained a comparison of the average Spreading Factor to Throughput (bytes/s). in research [19] data generated from research on LoRa are AWGN Channel and Rayleigh channel, Loss of Received signal Power to maintain PER = 10⁻¹ as in AWGN channel when the end-devices velocity is 30 km / h.

D. Fresnel Zone Approach

In this research, transmitting data from the 915 Mhz LoRa Transmitter to the 915 MHz LoRa Receiver with a long distance (Km). this affects the geographical location of the earth in the form of an ellipse. So a theory about the Fresnel Zone is formed. Fresnel Zone is an elliptical form on the Direct Line of Sight condition between the transmitter and Receiver. furthermore, The formula for calculating radius in the Fresnel Zone is as $r = 8,657 \times \sqrt{(D/f)}$, $r =$ Fresnel Zone radius (m), $D =$ distance (km), $f =$ frequency (GHz). so that from equation 1 a table of comparison of Fresnel Zone can be made radius (m) at a certain distance and certain Frequency, for example at a distance of 500 m or 0.5 Km and Radio Wave Frequency used is 915 MHz or 0.915 GHz then the Fresnel radius of Zonen $r = 8,657 \times \sqrt{(0,5 / 0,915)} = 6.3994$ meters, this condition is illustrated in Fig. 5. Conditions when sending BME280 sensor node data from the transmitter to the receiver node which can be seen from the Fresnel Zone Clearance condition. The Fresnel zone is the ellipse part that shows in Fig. 5(a), outside the ellipse part is not the Fresnel Zone. For this reason, the Fresnel Zone is influenced by the transmitting antenna height (H_T) and the receiving antenna height (H_R). analysis of data transmission between Transmitter (T_x) and Receiver (R_x) LoRa node is determined by the Fresnel zone to obtain the correct delivery results, in addition to the influence of the Fresnel zone, other influences, an obstacle (buildings, trees) and interference e.g.weather.

There are four states of the Fresnel Zone described in Fig. 13 and Fig. 14. Fig. 13(a) is the Fresnel Zone Equation Fig. 13(b) is the Condition Transmitter and Receiver without interference or no obstacle in the Fresnel Zone, Fig. 13(c) is Condition Transmitter and Receiver with a reflected signal from the ground surface and Fig. 13(d) is Conditional Transmitter and Receiver with considering factor H, H is heigh from curvature of the earth and to calculate $H = 1000 \times D^2 / (8 \times R_{earth})$, accordingly the theory, H is Height (or earth curvature allowance in m), D is the distance between the end node and the gateway in km, and R_{earth} is earth, the radius in km equal 8504 km. In full about the effect of Height (m) on the results of the calculation approach of the Fresnel Zone can be seen in Table IV. Moreover, Table IV is a comparison between the distance (km) to the height (m) of the arch of the earth, and this is an approach that is not significant right, considering the different areas when transmitting data.

The essence of adding Fresnel Zone parameters is to take into account the earth's curvature which affects Reflection, Diffraction and Scattering wave signal propagation, in this case, the position of Transmitter is important, tx should be placed at a position far higher than the Fresnel zone. Therefore, Fresnel Zone is used at distances between 5 km to 30 km.

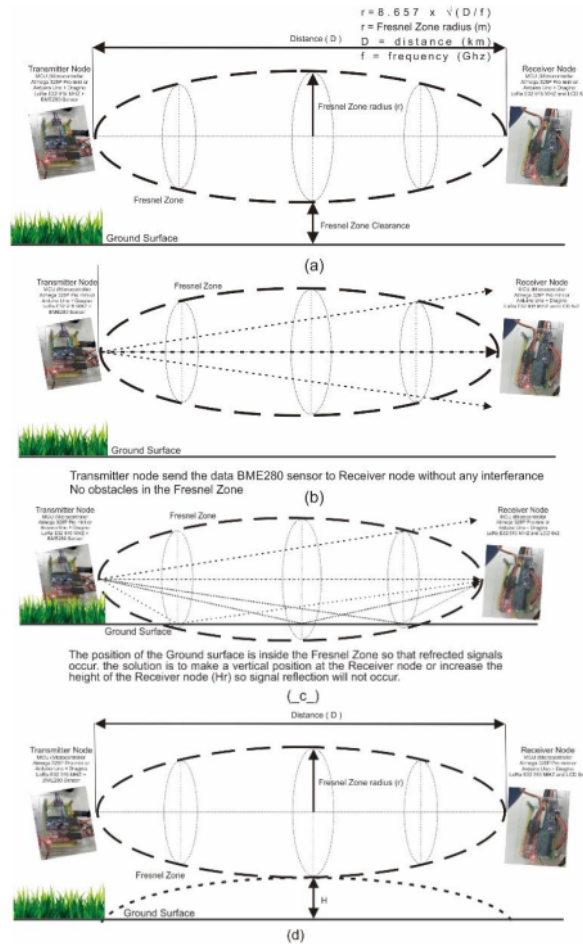

Fig. 13. Conditions of Fresnel Zone Theory.

TABLE IV. RESULT OF FRESNEL ZONE APPROACH WITH H CONSIDERATION

No	Distance (km)	Height (m)
1	0.1	Negligible
2	0.5	Negligible
3	1	Negligible
4	2	Negligible
5	5	0.4
6	10	1.5
7	15	3.3
8	20	5.9
9	25	9.2
10	30	13.2

Furthermore, the Fresnel Zone area is influenced by H_t and H_r, the higher the value of H_t and H_r, the greater the percentage of Fresnel zone clear, as shown in Fig. 14.

Then from the formula $r = 8,657 \times \sqrt{(D / f)}$, it changes to $r = 8,657 \times \sqrt{((0.7 \times D) / f)}$, this is caused by adding a Fresnel zone value of 70% or 0.7 x D.

Therefore, Fig. 15 shows the Comparison of Fresnel Zone Clear Percentage (%) with the Fresnel Zone approach with a

distance of 5 km produces a value of Fresnel Zone radius 100% clear as far as 639.9 m, Fresnel Zone 70% clear as far as 535.4 m, Fresnel Zone 60% as far as 495.6 m, and Fresnel zone 50% as far as 452.5 m. Furthermore, from Fig. 16 it can be concluded that the farther the distance (m) between the transmitter (Tx) to the LoRa (Rx) receiver, the greater the value of r (Fresnel zone), so that it will be more detailed if the addition of data is done using a comparison of Frequency The different LoRa are 433 MHz and 868 MHz in Fig. 16.

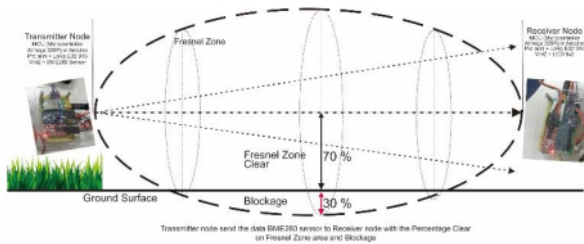

Fig. 14. Fresnel Zone 70% Clear.

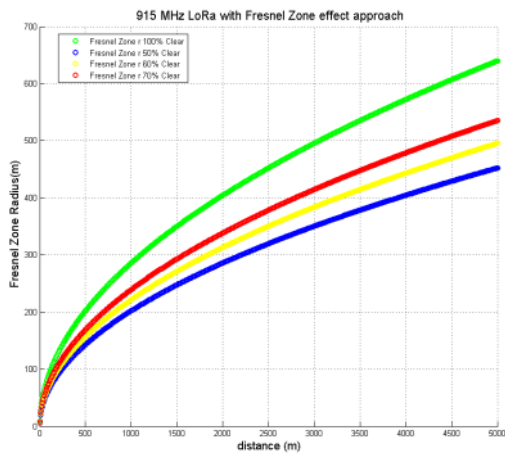

Fig. 15. Comparison of Fresnel Zone Clear Percentage (%).

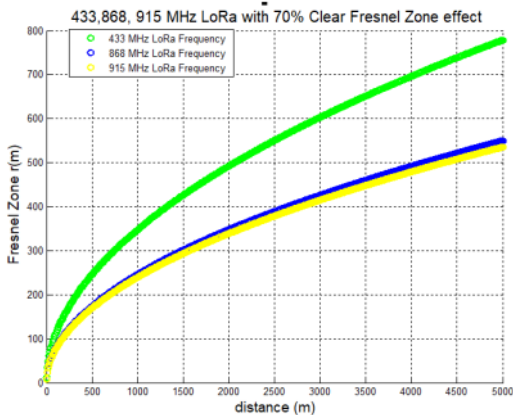

Fig. 16. Comparison of 70% Clear (30% Blockage) Fresnel Zone with different LoRa Frequency (433, 868 and 915 MHz).

In Fig. 16, 433 MHz Frequency of LoRa at a distance of 5 km has a value of Fresnel Zone as far as 778.3 m, 868 MHz as far as 549.7 m and 915 MHz as far as 535.4 m. so it was concluded that by transmitting LoRa data with Low Frequency and with the same Fresnel zone clear percentage condition (70%) has the furthest Fresnel zone (r) value. Please note that the H value is calculated when the distance is km 5 km. so the value of $r \geq 5$ km equals $r + H$, for example, $r + 0.4$ at a distance of 5 km and $r + 1.5$ at a distance of 10 km and so on as shown in Table IV.

E. Network Concept

Fig. 17 and Fig. 18 is a concept on this research, end devices/end nodes or mote consists of more than one sensor node connected to the LoRa Internet Gateway. Therefore, this LoRa Internet Gateway functions to store and capture LoRa signals from end devices to be forwarded to the e.g compatible Application Server, The Things Network or Thingspeak and then forwarded to Devices connected to Internet devices. The analysis stage is the data rate (byte/s) of the Uplink and Downlink process, continuous data transmission by the sensor node will make the battery run out quickly and this is undesirable in the LPWAN method.

In Fig. 17, by only using 1 LoRa Internet Gateway, packet data or data bytes will be a buildup of data bits from n-number end-nodes that send data to one source, consequently, this multiplexing method results in increasing the bit rate of Error Ratio (BER (%)) or Packet Error Ratio (PER (%)). therefore, we need an approach to the number of gateways that can dynamically manage packet data (bytes/s) coming in from end-node or end-device. End-node needs to use a sleep mode approach, therefore, it didn't continuously send packet data (bytes/s) without stopping causing bottleneck packet data (bytes) at the gateway. The addition of the gateway an answer, furthermore, the end node can select the destination gateway furthermore, that there no packet data buildup resulting in a reduction in throughput.

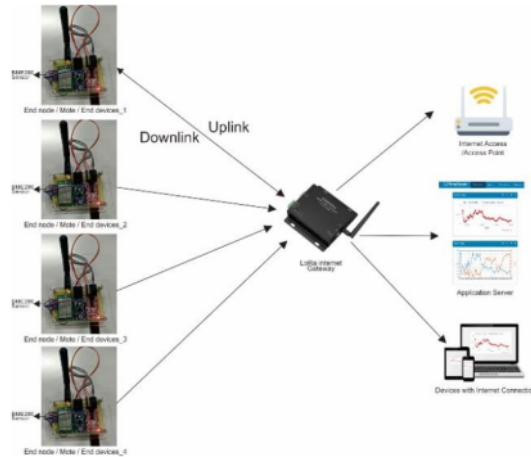

Fig. 17. Simple TT Network Concept.

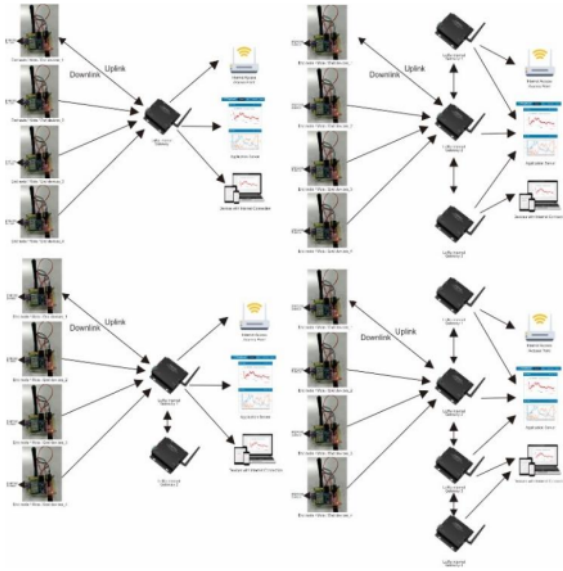

Fig. 18. Adaptive Data Rate (ADR) Algorithm TT Network Concept.

So we need an approach using an algorithm that can regulate the sending of data (byte/s) continuously by the sensor node or end node/mote to the gateway. The core of the ADR algorithm is that sensor nodes can dynamically switch to off or sleep mode so that power consumption can be reduced, therefore the lifetime on sensor nodes is getting longer. Therefore, the Adaptive Data Rate (ADR) algorithm is used to optimize data rates, airtime and energy consumption, the ADR Flowchart in Fig. 19.

F. Sleep Mode

Sleep mode is one way to manage LoRa data transmission using MCU, in this research the Arduino Pro mini MCU type 3.3 v, 8 MHz. in general the structure of the Sleep mode can be seen in Fig. 20.

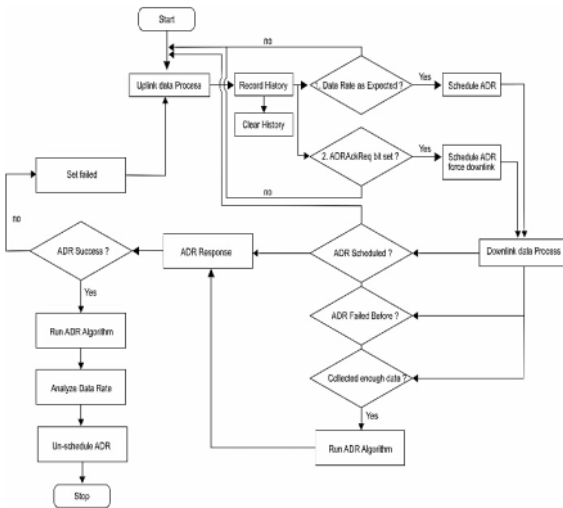

Fig. 19. Adaptive Data Rate (ADR) Flowchart.

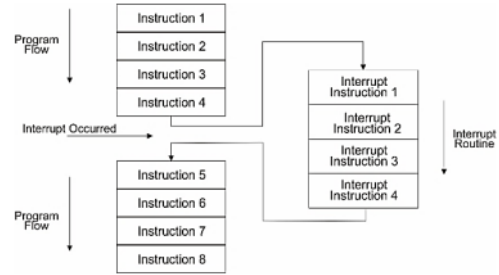

Fig. 20. Interrupt Process.

```

1. Initialization Sleep mode and LoRa Library
#include <RH_RF95.h>
#include <ThingSpeak.h>
#include <SPI.h>
#include <LoRa.h>
#include <avr/sleep.h>
#define interruptPin 2

2. Initialization Sensor Library
#include <Wire.h>

1. Initialization Boud Rate or Speed Data Rate (bps)
void setup() {
  Serial.begin(115200);
}

2. Initialization Input and Output
Serial.println("LoRa Sender");
if (!LoRa.begin(915E6)) //915MHz Freq
{
  Serial.println("Starting LoRa failed!");
}
pinMode(LED_BUILTIN,OUTPUT);
pinMode(interruptPin, INPUT_PULLUP);
digitalWrite(LED_BUILTIN,HIGH);
}

3. Determine the Sleep Time
void loop() {
  delay(10000);
  Going_To_Sleep();
}

4. Command to Sleep
void Going_To_Sleep(){
  rf95.sleep();
  sleep_enable();
  attachInterrupt(0, wakeUp, LOW);
  set_sleep_mode(SLEEP_MODE_PWR_DOWN);
  digitalWrite(LED_BUILTIN, LOW);
  delay(1000);
  sleep_cpu();
  Serial.println("Stop Transmit data LoRa and Sleep! ");
  digitalWrite(LED_BUILTIN,HIGH);
}

5. Command to WakeUp
void wakeUp() {
  Serial.println("Transmit data LoRa!");
  sleep_disable();
  detachInterrupt(0);
}

====Pseudocode 1. Sleep Mode Use Interrupt =====
    
```

IV. RESULT AND DISCUSSION

A. BME280 Sensor Output

Realtime data BME280 Sensor on the Serial monitor is an example of the output generated from the end node transmitter (Tx) to the Receiver (Rx). Shown in Fig. 21 and Fig. 22,

therefore, this output can be added to the analysis parameters, namely Receiver Signal Strength Indicator (RSSI) as in Fig. 23.

Fig. 22 is the Realtime Sensor node taken from the Serial monitor with a 9600 bps baud rate which is indicated by realtime time, temperature, humidity, and Air Pressure data.

Fig. 23 is the sending of Sensor data from the Transmitter (Tx) and Receiver (Rx) accompanied by RSSI Parameters, in addition to RSSI, SNR is also very necessary to determine the strength of the LoRa signal.

```

COM23
10:30:36.507 -> 24.24 DegC, 1010.10 hPa, 36.84 %
10:30:36.577 -> 24.24 DegC, 1010.10 hPa, 36.84 %
10:30:36.611 -> 24.24 DegC, 1010.10 hPa, 36.84 %
24.24 DegC, 1010.10 hPa, 36.84 %
10:30:36.715 -> 24.24 DegC, 1010.10 hPa, 36.84 %
24.24 DegC, 1010.10 hPa, 36.84 %
10:30:36.785 -> 24.24 DegC, 1010.10 hPa, 36.84 %
24.24 DegC, 1010.10 hPa, 36.84 %
10:30:36.889 -> 24.24 DegC, 1010.10 hPa, 36.84 %
10:30:36.923 -> 24.24 DegC, 1010.10 hPa, 36.84 %
10:30:36.958 -> 24.24 DegC, 1010.10 hPa, 36.84 %
10:30:36.993 -> 24.24 DegC, 1010.10 hPa, 36.84 %
10:30:37.063 -> 24.24 DegC, 1010.10 hPa, 36.84 %
10:30:37.096 -> 24.25 DegC, 1010.21 hPa, 36.83 %
10:30:37.130 -> 24.25 DegC, 1010.21 hPa, 36.83 %
10:30:37.165 -> 24.25 DegC, 1010.21 hPa, 36.83 %
    
```

Fig. 21. Realtime Sensor Data from End Node.

```

COM3 (Arduino/Genuino Uno)
Sending packet: TEMP : 25.73 DegC PRESS : 995.50 hPa HUM : 49.48 %
Sending packet: TEMP : 25.73 DegC PRESS : 995.44 hPa HUM : 49.48 %
Sending packet: TEMP : 25.73 DegC PRESS : 995.47 hPa HUM : 49.48 %
Sending packet: TEMP : 25.72 DegC PRESS : 995.44 hPa HUM : 49.45 %
Sending packet: TEMP : 25.74 DegC PRESS : 995.50 hPa HUM : 49.44 %
Sending packet: TEMP : 25.73 DegC PRESS : 995.39 hPa HUM : 49.49 %
Sending packet: TEMP : 25.74 DegC PRESS : 995.47 hPa HUM : 49.49 %
Sending packet: TEMP : 25.73 DegC PRESS : 995.50 hPa HUM : 49.51 %
Sending packet: TEMP : 25.74 DegC PRESS : 995.47 hPa HUM : 49.48 %
Sending packet: TEMP : 25.74 DegC PRESS : 995.44 hPa HUM : 49.52 %
Sending packet: TEMP : 25.74 DegC PRESS : 995.39 hPa HUM : 49.55 %
Sending packet: TEMP : 25.74 DegC PRESS : 995.44 hPa HUM : 49.54 %
Sending packet: TEMP : 25.74 DegC PRESS : 995.50 hPa HUM : 49.50 %
Sending packet: TEMP : 25.75 DegC PRESS : 995.47 hPa HUM : 49.51 %
Sending packet: TEMP : 25.75 DegC PRESS : 995.47 hPa HUM : 49.49 %

(a)

COM3 (Arduino/Genuino Uno)
* with RSSI -34
Received packet: TEMP : 25.68 DegC PRESS : 995.55 hPa HUM : 49.30 %
* with RSSI -34
Received packet: TEMP : 25.67 DegC PRESS : 995.49 hPa HUM : 49.30 %
* with RSSI -34
Received packet: TEMP : 25.67 DegC PRESS : 995.49 hPa HUM : 49.29 %
* with RSSI -34
Received packet: TEMP : 25.67 DegC PRESS : 995.55 hPa HUM : 49.32 %
* with RSSI -34
Received packet: TEMP : 25.67 DegC PRESS : 995.52 hPa HUM : 49.33 %
* with RSSI -34
Received packet: TEMP : 25.67 DegC PRESS : 995.47 hPa HUM : 49.32 %
* with RSSI -34
Received packet: TEMP : 25.67 DegC PRESS : 995.52 hPa HUM : 49.30 %
* with RSSI -34
    
```

Fig. 22. Data Transmit (a) and Receive (b) on Serial Monitor with RSSI (-dBm) value.

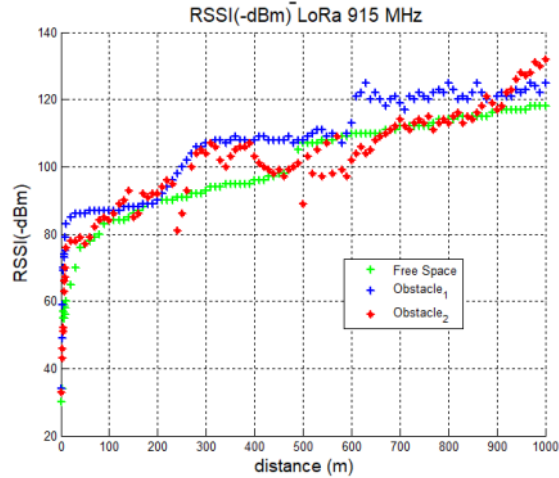

Fig. 23. RSSI (-dBm) LoRa 915 MHz.

B. Signal Analyze with Analyzer

Fig. 24 and Fig. 25 shows when the LoRa transmitter is on, it will appear in the Analyzer a noise and signal that moves at the amplitude and signal strength (-dB) at a frequency that matches the radio Frequency LoRa used. (a) is the high LoRa signal when sending sensor data, in this section expressed by the high signal that is the Amplitude signal, while (b) is the Noise, which is part of the LoRa Frequency signal or radio wave. Fig. 24 is the LoRa signal which consists of two parts, the LoRa signal and the noise signal at the bottom. Therefore, Power Noise can be determined from the strength of the LoRa signal.

Fig. 26 is analog demodulation, i.e. IQ versus time, Inphase and Quadrature (IQ) is two amplitude sinusoidal waves with phase is one-quarter cycle ($\pi / 2$ radians). Inphase and Quadrature signals are expressed in equation x. In realtime the Inphase and Quadrature signal can be seen in Fig. 8. The yellow color is the amplitude of the In-phase signal and the Green color is the amplitude of the Quadrature signal. Quadrature and phase show the sending of a LoRa signal. therefore, LoRa uses the FSK (Frequency Shift Keying) method if it is shown in the wave signal amplitude in Fig. 27, then the signal density shows the sending of LoRa data in realtime and a low signal or low frequency indicates no LoRa signal.

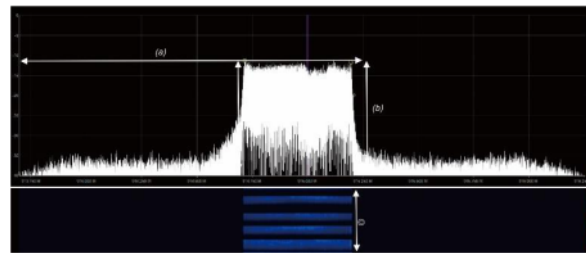

Fig. 24. LoRa Signal Analyze with SDR v.1.0.0.1700 RTL-SDR.

$$s(t) = e^{j(2\pi f_c t + 2\pi \frac{\beta}{2} t^2)} \quad (4)$$

$$\beta = \frac{BW}{T_{symb}} \quad (5)$$

$$T_{symb} = \frac{2^{SF}}{BW} \cdot CR \quad (6)$$

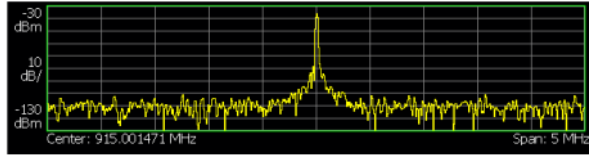

Fig. 25. LoRa Signal Analyze with Tectronix RSA 3408B Analyzer.

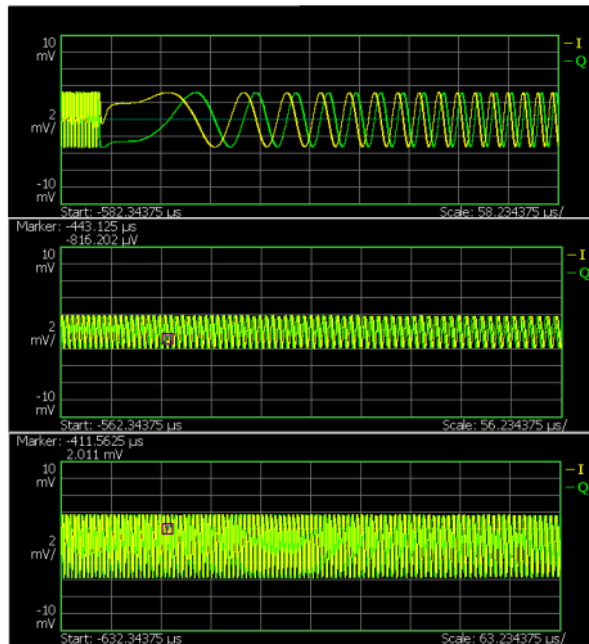

Fig. 26. Inphase and Quadrature (IQ).

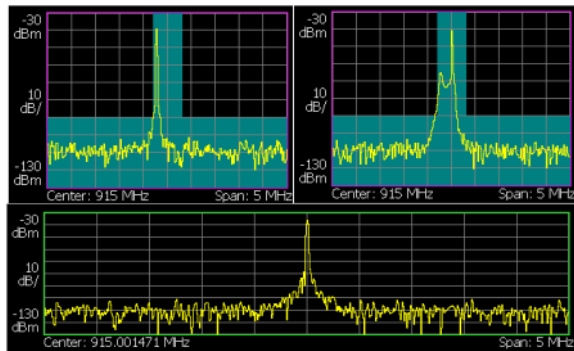

Fig. 27. Transmit Power LoRa Signal (dB).

C. Output Sensor on Application Server

The sensor output is shown in the Fig. 28(a) and (b). Taken from the application server e.g, Thingspeak, TTN. This data can be captured in realtime by smartphones, desktop computers, mini PCs or other devices connected to the internet network, so that data can be received easily and quickly, dynamically and freely, wherever they are.

D. Realtime Chirp Sinyal

During data transmission, the LoRa signal called CSS signal modulation (Chirps Spread Signal) can be seen in realtime using a Signal analyzer. Chirps signals consist of 2 Up Chirps and Down Chirps which are also called Preambles. And when the data is received, the Signal Chirps tend to be intermittent, because it contains LoRa data that is being transmitted. furthermore, Fig. 29(a), (b), (c) and (d) are examples of various Chirps LoRa signals.

Sensor node management is important to improve energy savings in the battery. therefore a requirement for analysis of a method using Arduino C Language to change the node to sleep mode and from the Gateway or Server-side is to use the Adaptive Data Rate (ADR) Algorithm method meaning the sensor node can dynamically transmit data on Gateway-1, Gateway-2 to Gateway-n, the adaptive means the data rate can be dynamically controlled by each node, the important function is for the effectiveness and management of the battery and sending data. furthermore, this will also reduce the percentage (%) of the Bit Error Rate (BER) and Packet Error Rate (PER) values. Therefore, This sensor node management pattern is to maintain Long Life or sensor node Lifetime in Wireless Sensor Network (WSN) which has a large number of nodes and by using LoRaWAN will enable Wireless Sensor Network Architecture with a wide range and small bit rate for monitoring data the sensor.

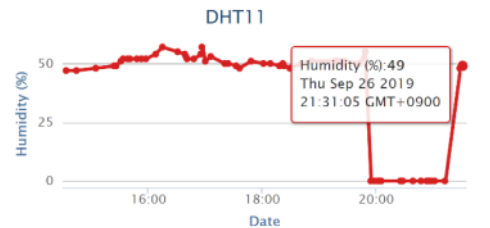

(a) DHT 11 Sensor IoT based.
BME_280

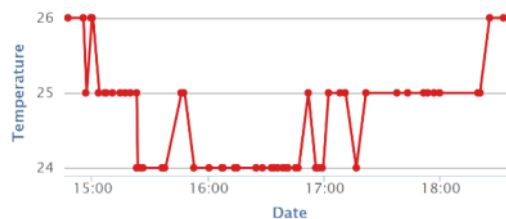

(b) BME_280 Sensor IoT based.

Fig. 28. (a) and (b), Output Sensor pada Application Server Thingspeak.

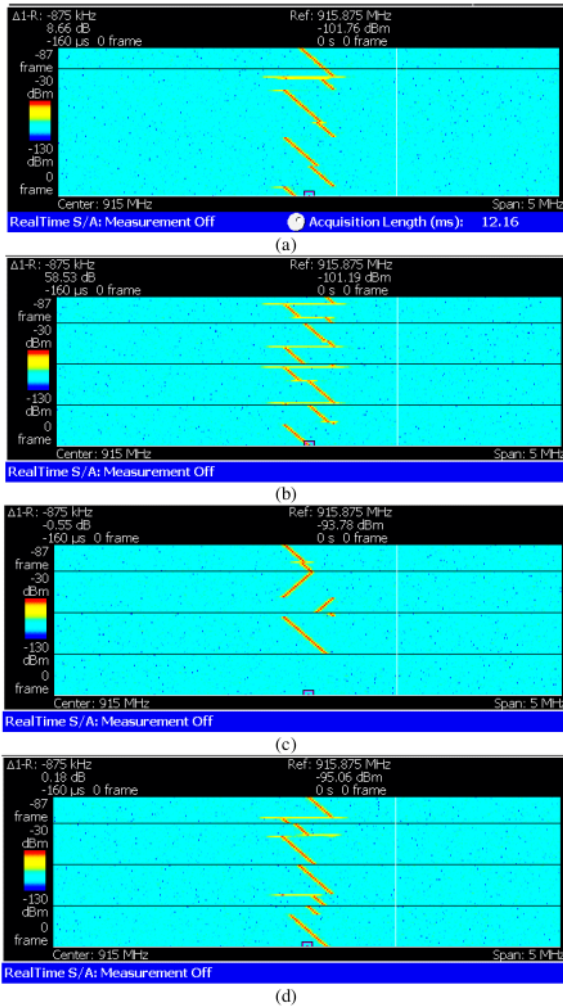

Fig. 29. (a) Start Chirp Signal (Preamble) (b) Realtime Chirp up-Down Chirp and Encoded Signal(c) Up and Down Chirp (d) Encoded Message Signal.

V. CONCLUSIONS

Transmission packet data (bytes/s) Long Range (LoRa) from End Devices or End Nodes using BME280 and DHT11 sensors Temperature sensor has been successfully, and furthermore, the packet data (bytes/s) sent to the ThingSpeak application server and can be seen in realtime on devices that have an internet connection. Furthermore, the LoRa signal sending data realtime can be received by the Signal Analyzer according to the LoRa Signal Radio Frequency used in this research and produce a Signal Chirp (CSS). In the next research, it is hoped that it can be further investigated, i.e., broadcast data transmission, therefore, that the weaknesses of the Gateway can be identified and what and what algorithm approaches can be used so that the sensor data analysis is detailed.

ACKNOWLEDGMENT

Thanks for Micro Electronics Research Laboratory (MeRL) Kanazawa University, JAPAN for supporting through a materials e.g., devices, analyzer. and to Professor Akio Kitagawa who has guided the writer and has provided support and role models.

REFERENCES

- [1] Puput Dani Prasetyo Adi and Akio Kitagawa, "ZigBee Radio Frequency (RF) Performance on Raspberry Pi 3 for Internet of Things (IoT) based Blood Pressure Sensors Monitoring" International Journal of Advanced Computer Science and Applications(IJACSA), 10(5), 2019. DOI: 10.14569/IJACSA.2019.0100504.
- [2] Puput Dani Prasetyo Adi and Akio Kitagawa, "Quality of Service and Power Consumption Optimization on the IEEE 802.15.4 Pulse Sensor Node based on Internet of Things" International Journal of Advanced Computer Science and Applications(IJACSA), 10(5), 2019. DOI: 10.14569/IJACSA.2019.0100518.
- [3] V. Fialhoab, F. Azevedoa, "Wireless Communication Based on Chirp Signals for LoRa IoT Devices",i-ETC: ISEL Academic Journal of Electronics, Telecommunications and Computers, IoT-2018 Issue, Vol. 4, n. 1 (2018) ID-6.
- [4] Puput Dani Prasetyo Adi and Akio Kitagawa, "Performance Evaluation WPAN of RN-42 Bluetooth based (802.15.1) for Sending the Multi-Sensor LM35 Data Temperature and RaspBerry Pi 3 Model B for the Database and Internet Gateway" International Journal of Advanced Computer Science and Applications(IJACSA), 9(12), 2018. DOI: 10.14569/IJACSA.2018.091285.
- [5] Puput Dani Prasetyo Adi, Rahman Arifuddin , "Design Of Tsunami Detector Based Sort Message Service Using Arduino and SIM900A to GSM/GPRS Module", JEEMECs (Journal of Electrical Engineering, Mechatronic and Computer Science) Volume 1, No.2, 2019, ISSN : 2614-4859, DOI:10.26905/jeemecs.v1i1.1982.
- [6] Rudy Susanto, Wiedjaja, James Anthony, Jacksen, "Comparison of three LoRa devices and its application on street light monitoring system", 2018 IOP Conf. Ser.: Earth Environ. Sci. 195 012066, doi:10.1088/1755-1315/195/1/012066.
- [7] Jetmir Haxhibeqiri, Eli De Poorter, Ingrid Moerman and Jeroen Hoebeke, "A Survey of LoRaWAN for IoT: From Technology to Application", Sensors 2018, 18, 3995; doi:10.3390/s18113995.
- [8] Marco Cattani, Carlo Alberto Boano and Kay Römer, "An Experimental Evaluation of the Reliability of LoRa Long-Range Low-Power Wireless Communication", Institute for Technical Informatics, Graz University of Technology, Graz 8010, Austria; J. Sens. Actuator Netw. 2017, 6, 7; doi:10.3390/jsan6020007.
- [9] Muhammad Omer Farooq, Dirk Pesch "Extended LoRaSim to Simulate Multiple IoT Applications in a LoRaWAN", International Conference on Embedded Wireless, Systems and Networks (EWSN) 2018.
- [10] Aloys Augustin, Jiazi Yi, Thomas Clausen and William Mark Townsley, "A Study of LoRa: Long Range & Low Power Networks for the Internet of Things", Sensors 2016, 16, 1466; doi:10.3390/s16091466.
- [11] Amir Mahmood, Emiliano Sisinni, Lakshminanth Guntupalli, Raul Rondon, Syed Ali Hassan and Mikael Gidlund, "Scalability Analysis of a LoRa Network under Imperfect Orthogonality", IEEE Transactions on Industrial Informatics, Volume 15, Issue:3, March 2019. DOI: 10.1109/TII.2018.2864681.
- [12] Alexandre Guiton, Megumi Kaneko, "Decoding Superposed LoRa Signals", The 43rd IEEE Conference on Local Computer Networks (IEEE LCN), October 1-4, 2018, Chicago, USA, DOI: 10.1109/LCN.2018.8638253.
- [13] Taoufik Bouguera, Jean-François Diouris, Jean-Jacques Chaillout, Randa Jaouadi and Guillaume Andrieux, "Energy Consumption Model for Sensor Nodes Based on LoRa and LoRaWAN", Sensors 2018, 18, 2104; doi:10.3390/s18072104.

- [14] Chun-hao liao , Guibing zhu, Daiki kuwabara, Makoto suzuki, and Hiroyuki Morikawa, "Multi-Hop LoRa Networks Enabled by Concurrent Transmission", IEEE Access, DOI: 10.1109/ACCESS.2017.2755858.
- [15] Guillaume Ferré, Audrey Giremus. LoRa Physical Layer Principle and Performance Analysis. ICECS 2018 25th IEEE International Conference on Electronics Circuits and Systems, Dec 2018, Bordeaux, France. hal-01977497.
- [16] Norbert Blenn and Fernando Kuipers, "LoRaWAN in the Wild: Measurements from The Things Network", Delft University of Technology, Mekelweg 4, 2628 CD Delft, The Netherlands, arXiv:1706.03086v1 [cs.NI] 9 Jun 2017.
- [17] Akram H. Jebril, Aduwati Sali, Alyani Ismail and Mohd Fadlee A. Rasid, "Overcoming Limitations of LoRa Physical Layer in Image Transmission", Sensors 2018, 18, 3257; doi:10.3390/s18103257.
- [18] Ferran Adelantado, Xavier Vilajosana, Pere Tuset-Peiro, Borja Martínez, Joan Melià-Seguí, Thomas Watteyne, "Understanding the Limits of LoRaWAN", IEEE Communication magazines 2017, arXiv:1607.08011v2 [cs.NI] 13 Feb 2017.
- [19] Xuan-Chien Le, Baptiste Vrigneau, Matthieu Gautier, Malo Mabon, Olivier Berder. "Energy/Reliability Trade-off of LoRa Communications over Fading Channels". International Conference on Telecommunication, Jun 2018, Saint-Malo, France. hal-01816574.

Performance Evaluation of E32 Long Range Radio Frequency 915 MHz based on Internet of Things and Micro Sensors Data

ORIGINALITY REPORT

16%

SIMILARITY INDEX

13%

INTERNET SOURCES

6%

PUBLICATIONS

8%

STUDENT PAPERS

PRIMARY SOURCES

1	core.ac.uk Internet Source	5%
2	Submitted to Cornell University Student Paper	2%
3	webthesis.biblio.polito.it Internet Source	2%
4	image.micros.com.pl Internet Source	1%
5	Submitted to University of South Australia Student Paper	1%
6	www.ebyte.com Internet Source	<1%
7	Submitted to University of Nottingham Student Paper	<1%
8	dokumen.pub Internet Source	<1%
9	hal.archives-ouvertes.fr Internet Source	<1%

10	tudr.thapar.edu:8080 Internet Source	<1 %
11	res.mdpi.com Internet Source	<1 %
12	www.mdpi.com Internet Source	<1 %
13	www.mobilefish.com Internet Source	<1 %
14	Submitted to University Computing Centre (SRCE) Croatia Student Paper	<1 %
15	Submitted to Panjab University Student Paper	<1 %
16	Puput Dani Prasetyo Adi, Akio Kitagawa. "Performance Evaluation WPAN of RN-42 Bluetooth based (802.15.1) for Sending the Multi-Sensor LM35 Data Temperature and RaspBerry Pi 3 Model B for the Database and Internet Gateway", International Journal of Advanced Computer Science and Applications, 2018 Publication	<1 %
17	Gurkan Dogan, Gungor Yildirim, Yetkin Tatar. "Empirical Observations on LoRa Performance for Different Environments", 2019 International Conference on Applied	<1 %

Automation and Industrial Diagnostics (ICAAID), 2019

Publication

18

acta.bibl.u-szeged.hu

Internet Source

<1 %

19

Submitted to University of Hong Kong

Student Paper

<1 %

20

Hung Huy Khong, Bing W. Kwan, Leonard J. Tung. "Path loss revisited using computer simulation", 2009 IEEE International Conference on Systems, Man and Cybernetics, 2009

Publication

<1 %

21

Roberts, Gordon. "An Introduction to Mixed-Signal IC Test and Measurement", Oxford University Press

Publication

<1 %

22

dione.lib.unipi.gr

Internet Source

<1 %

23

rossz-bel.com

Internet Source

<1 %

24

Ashraf A.. "Memetic Multi-Objective Particle Swarm Optimization-Based Energy-Aware Virtual Network Embedding", International Journal of Advanced Computer Science and Applications, 2015

Publication

<1 %

25 Hongqiang Li, Yubing Zhang, Xu Zhao, Xiaoke Tang. "Delay CoMP of LoRa Modulation in Wireless Tree Topology Network", 2019 IEEE 19th International Conference on Communication Technology (ICCT), 2019
Publication <1 %

26 Lathi, B.P.. "Modern Digital and Analog Communication", Oxford University Press
Publication <1 %

27 Miryam Paredes, Silvano Bertoldo, Lorenzo Carosso, Claudio Lucianaz, Emanuele Marchetta, Marco Allegretti, Patrizia Savi. "Propagation measurements for a LoRa network in an urban environment", Journal of Electromagnetic Waves and Applications, 2019
Publication <1 %

28 forum.arduino.cc
Internet Source <1 %

29 Puput Dani Prasetyo Adi, Volvo Sihombing, Victor Marudut Mulia Siregar, Gomal Juni Yanris et al. "A Performance Evaluation of ZigBee Mesh Communication on the Internet of Things (IoT)", 2021 3rd East Indonesia Conference on Computer and Information Technology (EIConCIT), 2021
Publication <1 %

30

Taoufik Bouguera, Jean-François Diouris, Jean-Jacques Chaillout, Randa Jaouadi, Guillaume Andrieux. "Energy Consumption Model for Sensor Nodes Based on LoRa and LoRaWAN", *Sensors*, 2018

Publication

<1 %

Exclude quotes Off

Exclude matches Off

Exclude bibliography On

Performance Evaluation of E32 Long Range Radio Frequency 915 MHz based on Internet of Things and Micro Sensors Data

GRADEMARK REPORT

FINAL GRADE

/0

GENERAL COMMENTS

Instructor

PAGE 1

PAGE 2

PAGE 3

PAGE 4

PAGE 5

PAGE 6

PAGE 7

PAGE 8

PAGE 9

PAGE 10

PAGE 11

PAGE 12
